

# THINGS THAT FLY

Shirley Sydenham & Ron Thomas

## Starting off

How many things that fly can you list in one minute?

Some things are obvious, but some don't pop into your mind so fast.

*Hint: machines, animals, plants, perhaps things that are no longer seen, perhaps mythical beasts or people.*

Take another minute and see how many things you can add to the list!

## Construct a Timeline

Go online [www.kidcyber.com.au/air-transport-a-timeline](http://www.kidcyber.com.au/air-transport-a-timeline) to take a look at some of the milestones in the development of getting humans into the air.

Choose 6-8 events in the development of humans in flight that you think are important. You will construct a timeline using those events. A timeline is a way of presenting a list of events that happened over a period of time. It is made up of specific dates or just the year or century, in order, and labelled.

Here are some examples of timeline layout that you can use or that will give you an idea of your own layout. In the examples there is just sample text. You will write your own, and replace numbers with years.

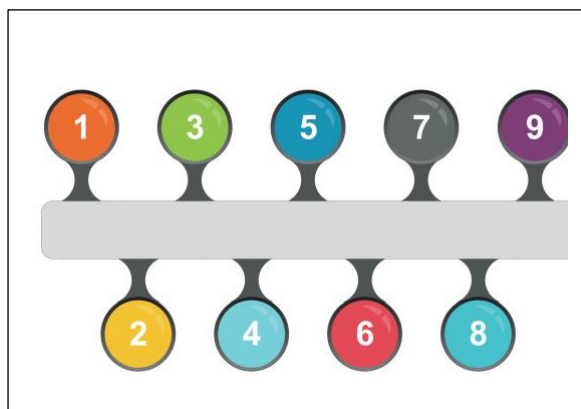
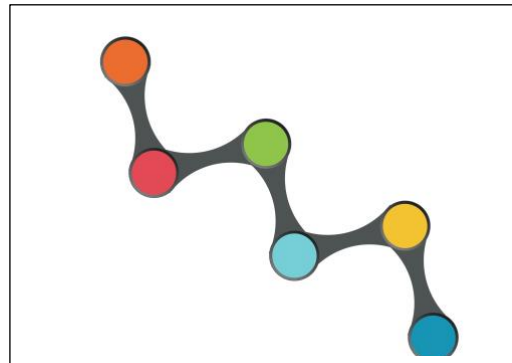

Give your timeline a title.

The timeline will read left to right starting with the earliest year and moving on towards the right.

## Hot air balloons and airships

Balloons and airships are lighter-than-air craft and are typically filled with gas, such as helium.

Hot air balloons are very popular for short joy rides for sightseeing, but were used for travel. Airships were once used for transporting passengers and cargo but today they are used for overhead filming (mostly for sporting events) and advertising.

Some airships have inflatable air compartments and are called blimps and some have rigid air compartments and are called zeppelins.

Write some questions about:

- The Montgolfier brothers
- How airships were powered and flew
- The Hindenberg disaster on 6 May 1930
- How hot air balloons work
- How hot air balloons are steered

Use a search engine to find information and diagrams about hot air balloons and airships. How do they fly? Look for the history of each.

Print or copy **Research Notes**, page 27, on which to write your research questions and notes.

Write up your notes as a report, booklet or chart. See chart suggestions, page 30. Include labelled illustrations.

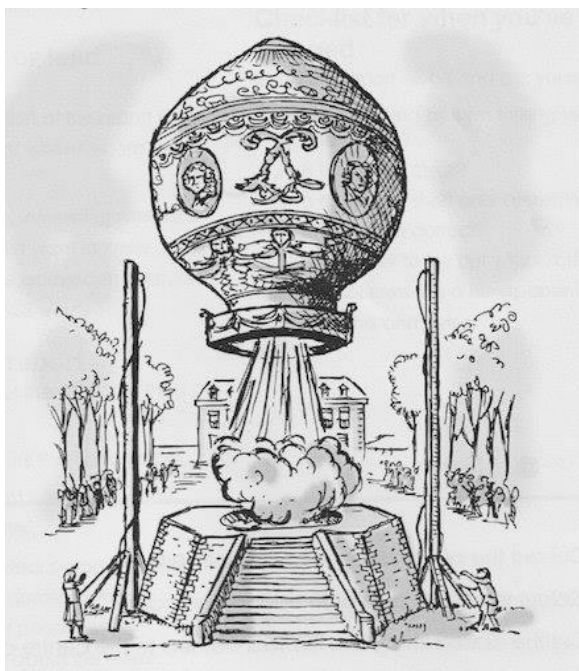

*The first hot air balloon free flight (not tethered by rope holding it to the ground) carrying people was on 21 November 1783.*

*Built by the Montgolfier brothers, it flew for about 25 minutes before landing.*

## The Wright Brothers, aviation pioneers

If an airship is a lighter-than-air craft, then aeroplanes are heavier-than-air craft.

The first controlled, sustained aeroplane flight was by the Wright brothers' *Kitty Hawk*. It took place on 17 December 1903. Find out about the Wright Brothers and their work and discoveries that led to this moment that changed history.

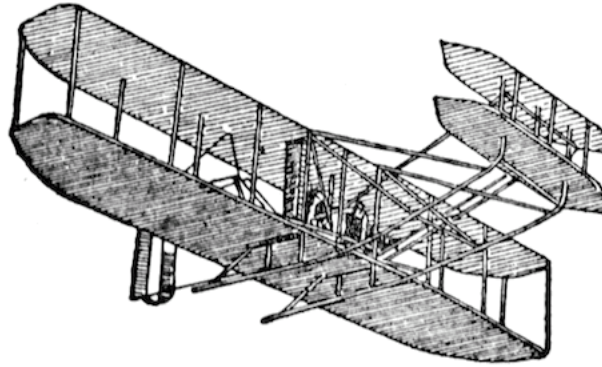

Go to [www.kidcyber.com.au/wright-brothers](http://www.kidcyber.com.au/wright-brothers), where there are also links to other information websites.

Write an imaginary newspaper interview with Orville and Wilbur Wright.

Print or copy Research Notes, page 29, on which to write your research questions and notes.

## Future Flight

What do you think will be the next major development in the history of humans flying?

Imagine that a new transport system has been announced. What is it like? What does it do that is new and exciting? What is it called? How much does it cost for its passengers?

Write:

- A newspaper report or magazine report
- **Or** an infommercial for TV
- **Or** a government brochure explaining how it works, how you use it and where it goes.

## How aeroplanes fly

An aeroplane flies because the air moving over and under all parts of it, particularly the wings, travels at different speeds.

Four forces affect an aeroplane: thrust, drag, gravity and lift.

To take off and keep flying, powerful engines drive the plane forward, giving it **thrust**. The aeroplane's thrust must be greater than the effect of drag.

**Drag** is the force of the air against the plane as it travels through it.

Drag is kept low by the sleek, aerodynamic shape of the plane's wings, which allows the plane to slip through the air.

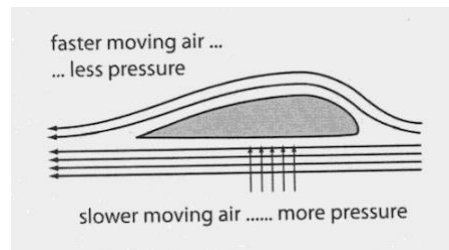

To rise into the air and overcome the force of gravity, the plane needs a force called **lift**. The air passing over the curved top surface of the wing has to move faster than the air passing underneath it. The fast moving air creates an area of lower air pressure above the wing and the plane is pulled up. At the same time the slow moving air under the wing creates an area of high pressure, which pushes the plane up from below.

**Lift** must be greater than the force of gravity, a force that pulls things down to the Earth's surface.

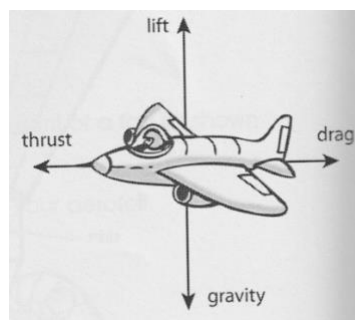

## What about landing?

The pilot slows the engines to reduce thrust and drag. The air pressure above and below the wings begins to even out, reducing lift and the Earth's gravity pulls the plane towards the ground.

*Now do the worksheet on page 14*

## How birds fly

In order to fly, birds must overcome two natural forces – **gravity** and **drag**.

- **Gravity** is the force that draws things to the ground. For example, when you drop something, it falls to the ground.
- **Drag** is the force that slows things down. For example, if you put out an arm when riding your bike fast, you can feel drag.

In order to fly, birds must *create* two forces – **lift** and **thrust** – to overcome the forces of gravity and drag.

**Lift** pushes the bird upwards, away from the ground. It overcomes gravity. Flapping wings does not cause lift, because birds soar and glide once they are up in the air.

A bird's wings are not flat, but curved. The shape is called an aerofoil. Air splits in two, some passing over the aerofoil and the rest passing underneath. The air stream above has further to go and speeds up. The air passing below the wing goes slower, creating more pressure and pushing the wing up. So air moving over the wings pulls the bird up and air moving below pushes the bird up.

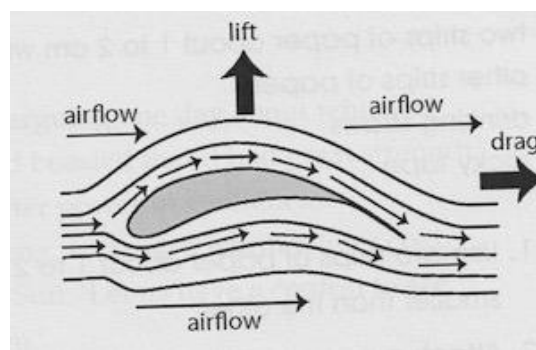

**Thrust** is the force that overcomes drag and pushes the bird forwards. It overcomes drag.

Birds don't flap their wings straight up and down. When the wing goes upward, the tip moves slightly backwards. When the wing goes downwards, the tip moves forwards slightly and the wing feathers twist slightly. Air passing over the top of the twisted feathers creates a forward push, or thrust.

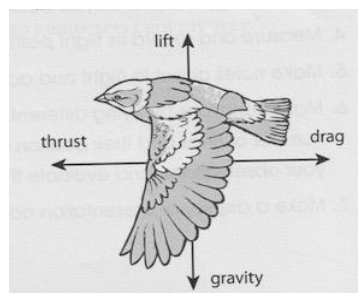

*Now do the worksheet on page15*

## How a helicopter flies

A helicopter is an aircraft that has two jet engines that drive and turn two or more rotor blades.

The rotor blades have an aerofoil shape, curved on the top and flat on the bottom, just like the wings of an aeroplane.

When the rotor blades rotate, the pressure of the air flowing under the blades is greater than the fast-moving air above them. The strong pressure below pushes the helicopter into the air, giving it the **lift** it needs to fly.

To move up, down, forward or backward or to hover motionless in the air, the pilot changes the angle, or tilt, of the helicopter's rotor blades.

The tail rotor gives the helicopter balance and stops it from spinning in the opposite direction to the rotor blades.

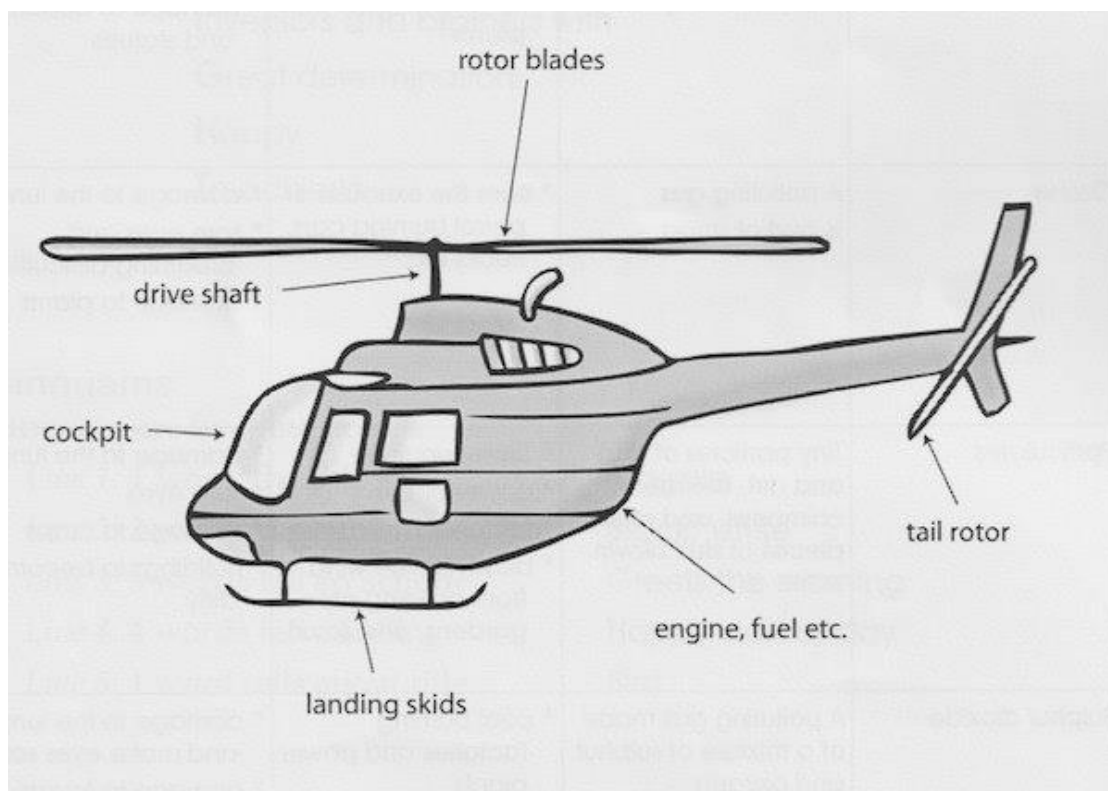

*Now do the activity about helicopters on page 16*

## Flying in space

Where is space? There is no line where 'space' begins, but it is universally agreed that 100 km (62 miles) above sea level is defined as the beginning of outer space. This measurement is used as a means of keeping aerospace records. It is known as the Kármán line.

In 1942, the German V2 was the first rocket to reach this 100 km point.

There are many milestones in the history of space flight, making a very long timeline.

Have a look at some space travel timelines. Most start with the launch of Sputnik in 1957 because that signalled the start of the 'space race' between the USA and what was then the USSR, but one of the timelines includes early milestones.

- <https://www.spacekids.co.uk/spacehistory/>
- <https://edition.cnn.com/2013/07/01/world/human-spaceflight-fast-facts/index.html>
- <https://www.australiangeographic.com.au/topics/science-environment/2012/08/timeline-of-space-exploration/>

The milestones in the development of space travel can be grouped in different ways to make a more manageable timeline. An example might be:

- early achievements in unmanned craft,
- animals in space,
- early short manned flights,
- manned flights to the moon,
- missions beyond the moon.

Choose some events that you think are significant.

Make an illustrated timeline of those events, giving some details about each one as well as the date.



*20 July 1969  
The first human footprint on the moon!*

*Neil Armstrong became the first human to step onto the moon's surface.*



## **The International Space Station**

The largest manned object in space is the International Space Station, or ISS. It is a large satellite on which changing teams of people live and work for a period of time. It has been continuously occupied since November 2000. It circles the Earth every 90 minutes and is visible in the night sky.

Find out about the ISS:

**[www.sciencekids.co.nz/sciencefacts/space/internationalpacestation.html](http://www.sciencekids.co.nz/sciencefacts/space/internationalpacestation.html)**

**[www.nasa.gov/mission\\_pages/station/main/index.html](http://www.nasa.gov/mission_pages/station/main/index.html)**

This one has links to further information about living in space:

**[www.kidcyber.com.au/international-space-station-iss](http://www.kidcyber.com.au/international-space-station-iss)**

Make notes about what you learn.

Imagine you work for an agency that recruits astronauts.

Use your notes to make an information booklet about living in space on the ISS and about getting there and back. You can include details of the training that would be required to take on this job.

Do you think it requires a special sort of person to take on that job?

Would you like to be an astronaut on the International Space Station?

What would appeal to you about doing that?

What would make you not want to do that?

Write your answers, giving all the reasons for and against.

Design for a space station, perhaps one that will undertake long space flights to other planets. Draw a labelled plan of your space vehicle.



**Print or copy Research Notes, page 28, on which to write your research questions and notes.**



## Make an aerofoil (or airfoil)

An aeroplane's wing, like a bird's, is not flat but curved.

A cross section of a plane's wing is an aerofoil, or curved shape. A cross section is a diagram of what you would see in an imaginary cut across the wing. A plane must overcome thrust and drag like a bird does.

To make an aerofoil, you need

- A piece of A4 paper
- Sticky tape
- A knitting needle or bamboo skewer
- Some lengths of thread or ribbon
- A piece of string or fishing line
- An electric fan

Cut the paper in half lengthwise. Tape down one end.

Use the knitting needle to make a hole about 1/3 of the way back from the fold, and through the centre of the raised hump in the paper.

You can tape ribbons on the aerofoil.

Thread a piece of string through the hole. Then hold the string taut and vertical (straight up and down), and hold the aerofoil in front of the fan.

Feel how the air flows over and under the aerofoil.

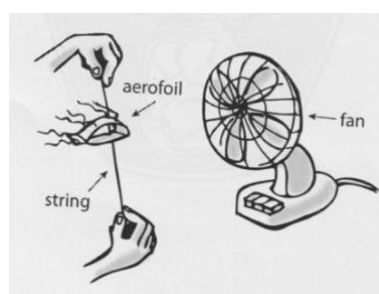
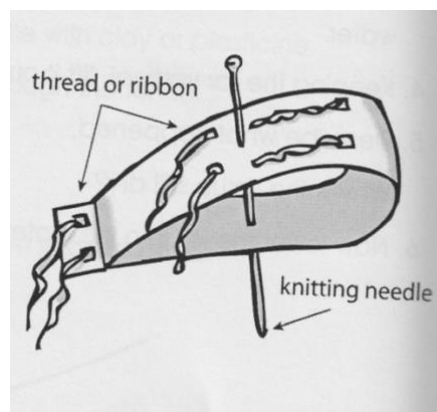

## Make and test paper gliders

Follow folding instructions to make paper gliders. If you know others, make those as well.

Test them all to see which design works best:

1. Guess first, then measure the distance each one flies.
2. Mark a target on paper and hang it up: how accurately does each glider fly?
3. Tear a hole in the centre of a double page of newspaper: see how many gliders you fly through the hole.

Use record sheet page 29 to report how each design performed, and your conclusion about which was the best and why.

Try again using different paper: does that make a difference to each design?

### A simple glider

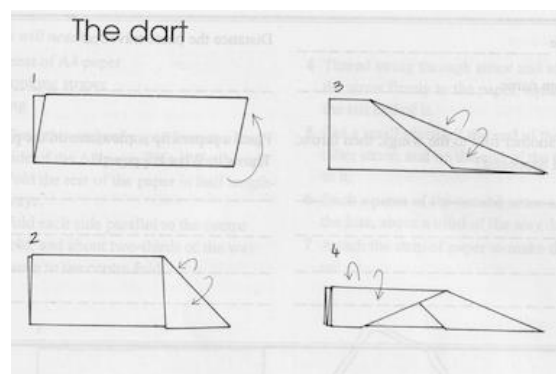
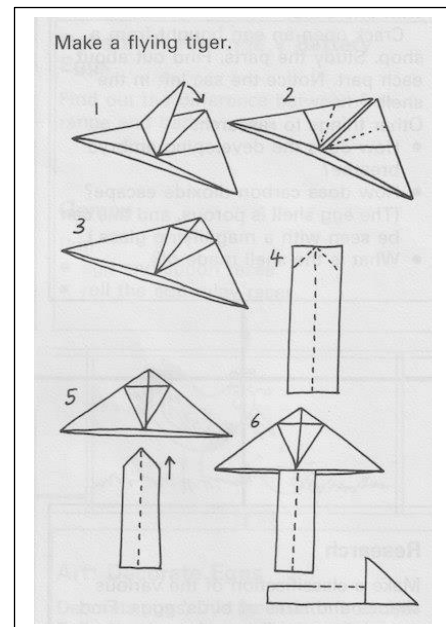
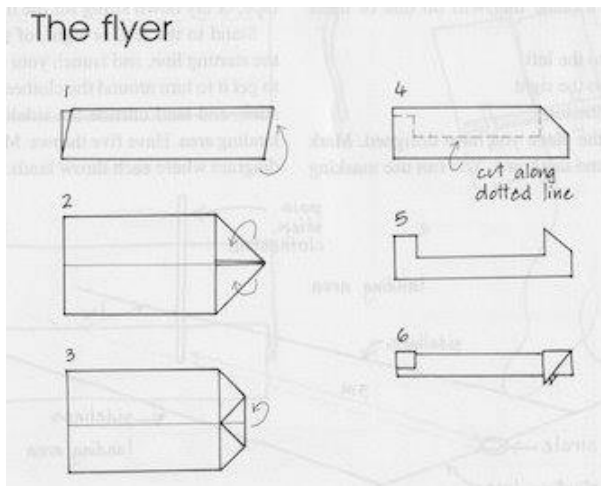
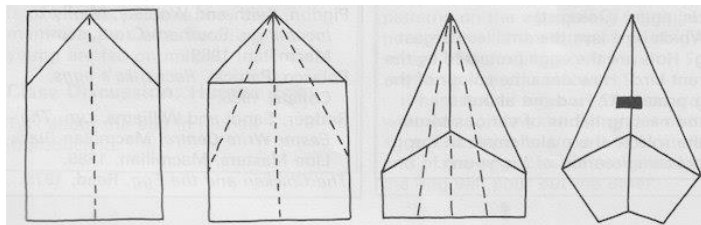

## Make and test a rotocopter

To make a paper rotocopter you need

- scissors,
- a paperclip,
- felt tip pens or coloured pencils
- paper of several different weights and thicknesses

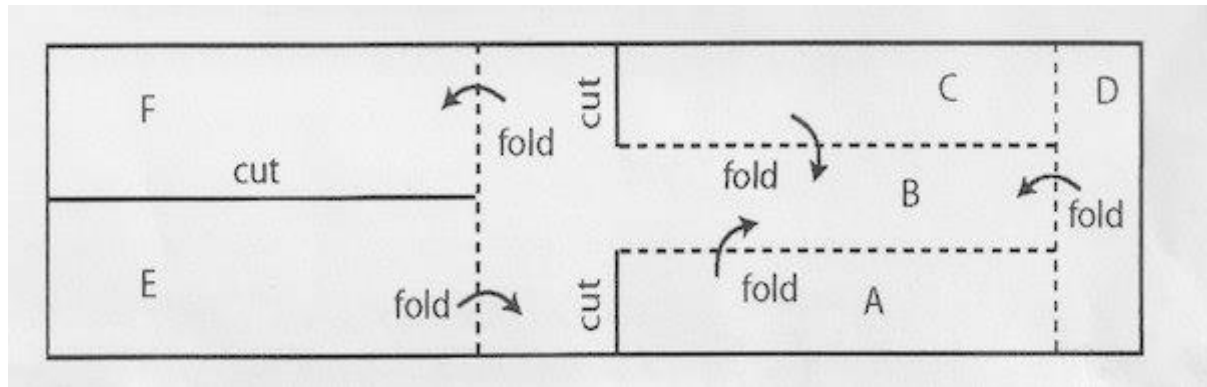

1. Copy or trace the pattern.
2. Cut out the pattern along the solid outside lines.
3. Decorate it.
4. Cut along the solid lines at the top of sections A and C.
5. Fold up section D, then fold A and C over B, and place a paperclip at the bottom.
6. Cut along the solid line between sections E and F.
7. Fold section E forward and section F back.

Test:

Stand on a chair. Guess the time it takes to land, then drop the rotocopter and time it. What happens?

What is the purpose of the paperclip?

Try adding more weight to the rotocopter. What happens?

Repeat, but with variations:

- make sections E and F longer
- use heavier paper

How do these changes affect the way the rotocopter flies?

Make other changes and observe the differences.

Use record sheet page 29.

Write a report about your experiment. Include the changes you made and tested, your observations of how each version of the rotocopter behaved.

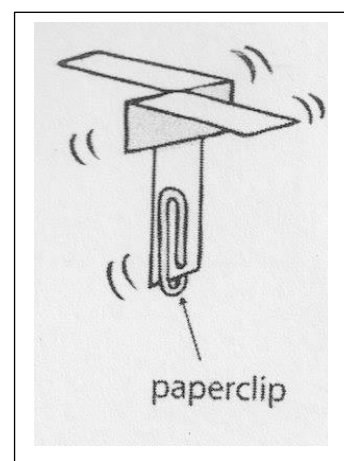

## Make and test a gyrocopter (or spinning glider)

You need

- Paper
- Drinking straws
- Sticky tape

Use two strips of paper about 1 to 2 cm wide to make two rings, one smaller than the other.

Attach a paper ring to each end of a drinking straw.

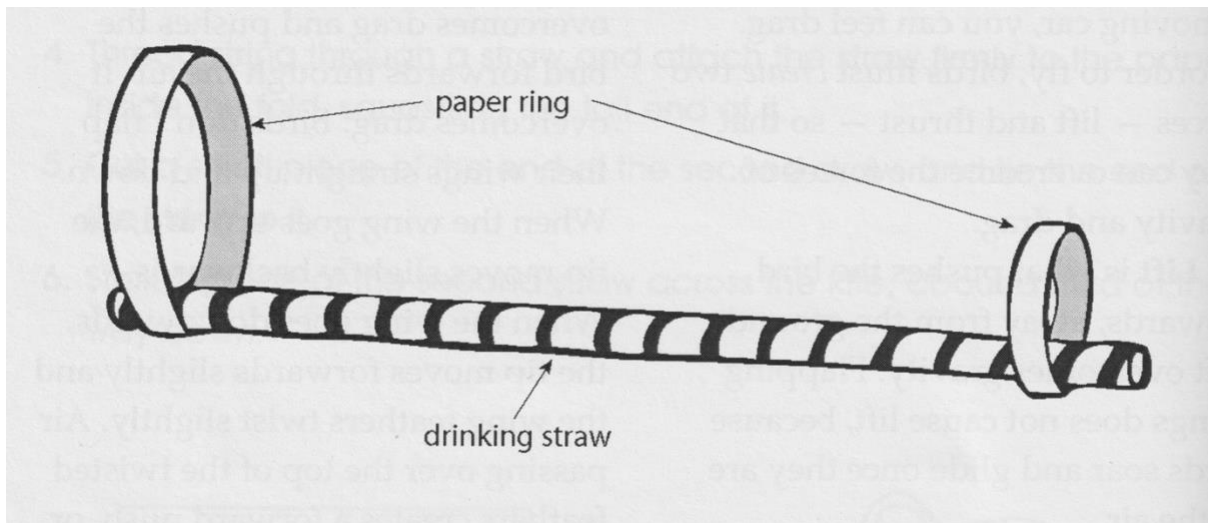

Throw the gyrocopter as you would a paper plane.

Guess first then measure and record the length of its flight.

Make some notes about its flight and action,

Make gyrocopters with different variations:

- Paper rings of different sizes and widths
- The number of rings
- The position of rings on the straw
- Paper of different weights or thickness

Take photos or make drawings of each gyrocopter.

Test your different gyrocopters and make notes about the length, steadiness and actions of each flight.

Use record sheet page 29 to report and evaluate the performances.

Write about your experiment and your conclusions.

## Make a parachute

A parachute allows a person or object falling from a great height to land on the ground safely.

This is related to flying because people jump from planes, for work, recreation or from necessity. Objects are dropped by parachute, for example, essential supplies that can't be delivered any other way in an emergency.

What natural forces in action are the same as those when planes and birds fly?

To make parachute you need:

- A plastic bag
- A marker pen
- Hole punch
- String
- Small toy to be the parachutist

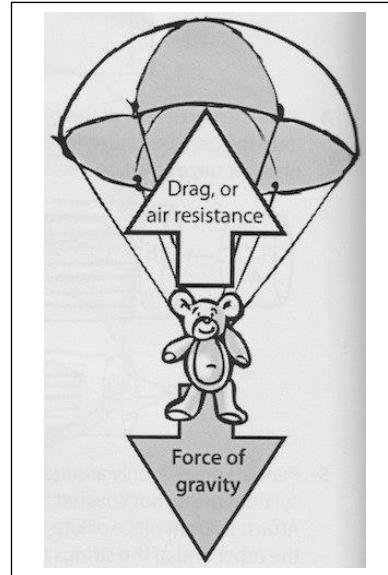

1. From the plastic, cut a circle 12 cm diameter. Mark the circle into 6 equal parts and make a small hole on each line near the edge of the circle.
2. Cut 6 strings of 18 cm each. Tie a string to each hole.

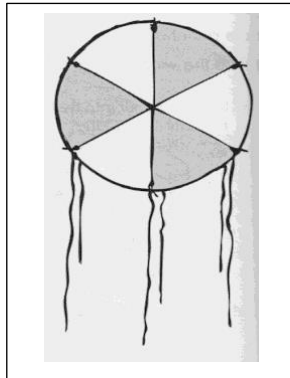

3. Tie the other end of the strings to the toy parachutist.
4. Hold the centre point of your parachute and drop it from a height such as from the top of some stairs. Do it safely. Time how long it takes to land.
5. Variation 1: Try attaching different toys to the parachute to see how the time to fall the same distance varies.
6. Variation 2: Make parachutes out of larger and smaller circles and compare how they perform.
7. Write a report of your tests and comparisons. Which performed best? Suggest a reason why it did.

### Worksheet: How an aeroplane flies

Label this diagram to show the 4 forces that affect a flying plane.

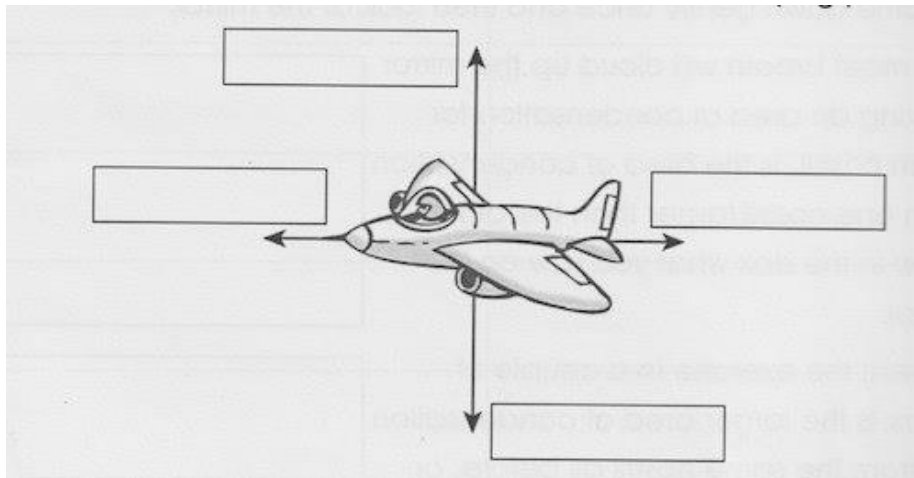

Explain thrust.

What causes lift?

Why does lift have to be greater than gravity?

**Worksheet: How birds fly**

**Answer the questions and label the diagram.**

Birds must overcome two natural forces, **gravity** and **drag**, in order to fly.

What is gravity?

What is drag?

How does the shape of a bird's wings help it to fly?

What is thrust?

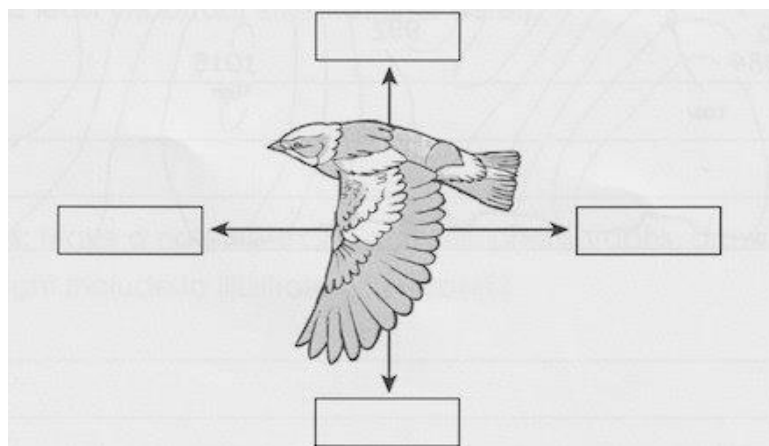



## **Worksheet: Helicopter presentation**

*Read the information page about helicopters on page xx*

Find out more information about helicopters and make notes.

Find out about the many different uses and designs of helicopters.

Make your notes under questions (good research questions often begin with words like who? What? Where? When? how?) so that the information is grouped.

Expand your notes into sentences and group them together in paragraphs.  
Your questions can be turned into headings.

Use the information you find to write helicopters.

You can make:

- a report, or
- a PowerPoint presentation or
- a booklet

You can go online to find out more information about how they work.

**<https://www.sciencekids.co.nz/sciencefacts/vehicles/helicopters.html>**

**<https://www.scienceforkidsclub.com/helicopters.html>**

Click on 'next page' to continue reading these two:

**<https://science.howstuffworks.com/transport/flight/modern/helicopter6.htm>**

**<https://science.howstuffworks.com/transport/flight/modern/helicopter1.htm>**

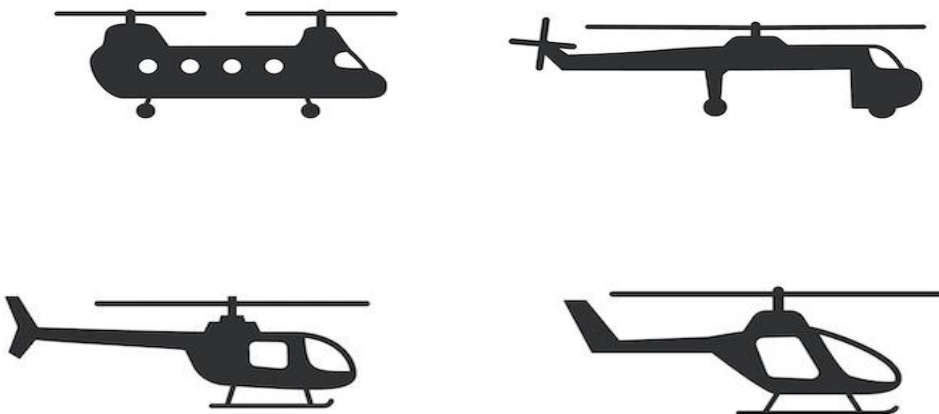

## **Gliders and Hang Gliders**

A **glider** is an aircraft that soars through the air without the help of a motor. In the early days of aeronautics, the planes were gliders with wooden frames and fabric. Once powered flight was developed, gliders became more of a recreational pastime.

Some **gliders** look very much like aeroplanes, with wings, a tail, a cockpit, an instrument panel, and body, or fuselage. Gliders are sometimes called sailplanes.

Write down what you already know about gliders.

Write some questions about what you would like to find out about them.

Read about gliders and make notes that answer your questions.

**<https://kids.kiddle.co/Gliding>**

**<https://www.grc.nasa.gov/WWW/K-12/airplane/glider.html>**

**<https://www.dkfindout.com/us/transportation/history-aircraft/early-gliders/>**

## **Hang gliders**

Some gliders are more like large kites with a harness where a person is suspended lying face down. The pilot runs downhill and launches into the air, then moves his or her feet into the harness until landing. Hang gliding is a recreation activity.

Most modern hang gliders are made of an aluminium frame covered with synthetic cloth that forms a wing.

Write down what you already know about hang gliders.

Write some questions about what you would like to find out about them.

Read about hang gliders and make notes that answer your questions.

**<https://www.sciencelearn.org.nz/resources/307-hang-gliders>**

**[https://kids.kiddle.co/Hang\\_gliding](https://kids.kiddle.co/Hang_gliding)**

**<https://www.dkfindout.com/us/transportation/history-aircraft/hang-gliders/>**

Print off or copy Research Notes, page 28, to write your research questions and information.

Use your information to make a chart or book, and you may like to make a model to go with it.

You can choose to find out about either gliders or hang gliders or both in order to do a project about gliding as a whole.

## **Bats**

There are animals that can glide, but bats are the only mammal that flies. There are more than 1000 different kinds of bat, but they are all nocturnal, or active at night.

Find the answers to these questions.

These sites may help but you may also find other websites or books.

<https://www.sciencekids.co.nz/sciencefacts/animals/bat.html>

<https://www.coolkidfacts.com/bat-facts-for-kids/>

How do bats find their way about and their food in the dark?

If they are active at night, how and where do they spend their days?

What do bats eat?

Which are the largest and the smallest bats?

Where are their wings located?

Are vampire bats real?

Are bats useful or are they pests?

## Animal gliders

There are about 60 mammals that glide. One group of those is possums. They don't fly, but glide instead, and the different ones do it the same way.

The sugar glider is one of them. Watch a video of a sugar glider and make some notes about how they are able to glide from tree to tree and why they do.

<https://www.nationalgeographic.com/animals/mammals/s/sugar-glider/>

Read more information about the sugar glider :

<https://www.kidcyber.com.au/possums>

Read some information about other gliding possums

- <https://www.bushheritage.org.au/species/gliders>
- <https://www.australiangeographic.com.au/topics/wildlife/2017/10/australian-marsupial-gliders/>

Print off or copy the research notes on page 28 to record your focus questions and notes about glider possums.

Use pieces of light card to make information cards. Write your notes on the cards in sentences and paragraphs. Make a hole in the top of each card.

Glider possums make nests in tree hollows. Hollows do not develop in young eucalyptus trees so glider possums live in forests with big, old trees. You will make a replica of a tree like that, and hang the information cards from the branches.

Use cardboard to make the tree.

Draw two tree shapes that widen at the bottom of the trunk.

Fold each tree down the middle of the trunk. Glue the tree trunks back to back at right angles.

Alternatively, draw and cut out the trees. On one, make a slit in the centre of the trunk from the top to the middle. On the other, make the slit from the bottom to the middle. The two tree shapes slot together along those slits.

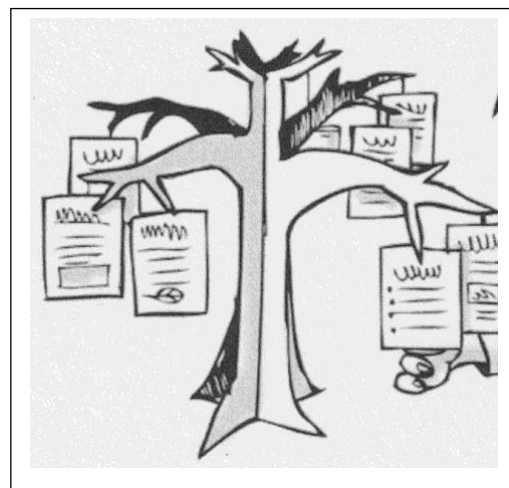

Either way, your tree will have four pieces at right angles to each other so the tree stands.

## Flying insects

There are millions of different kinds of insect, probably between 6-10 million. They don't have a skeleton inside their bodies, but instead have an exo-skeleton, which means the outside of their bodies are hard and the inside is soft.

They all have bodies consisting of three sections: head, thorax and abdomen.

They all have six legs.

They all have a four-stage life cycle: egg, larva, pupa, adult.

Find out about insects, and then find out about a particular insect or insects.

<https://www.sciencekids.co.nz/sciencefacts/animals/insect.html>

<https://www.kidcyber.com.au/insects>

<https://easyscienceforkids.com/all-about-insects/>

Beetles are insects, but they keep their wings neatly packed away.

Watch this video to see different beetles unpack their wings and fly.

<https://thekidshouldseethis.com/post/jewel-bugs-beetles-slow-motion>

Some flying insects spend their larval stage underwater or underground. Two examples are dragonflies and cicadas.

Find out about their life cycles:

<https://www.kidcyber.com.au/dragonflies-and-damselflies>

<https://www.kidcyber.com.au/cicadas>

Follow instructions to make a 16 page mini book about insects using the information you have found. You can focus on insects and their life cycle generally or do one kind of insect.

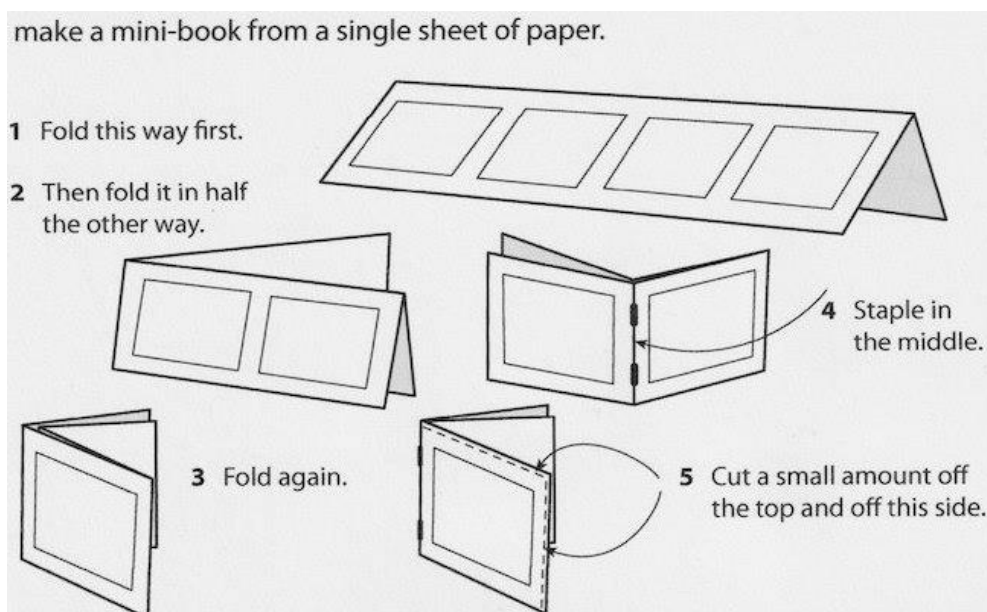

## **'Flying' snakes**

Yes, there are a few snakes that glide through the air!

There are five kinds, or species. They are sometimes called flying snakes.

Why do they do this?

How?

Where are they found?

How big are they?

What do they look like?

Read about them:

- <https://www.nationalgeographic.com/animals/reptiles/group/flying-snakes/>
- <https://factanimal.com/chrysopelea/>
- <https://www.kidsdiscover.com/quick-reads/southeast-asia-watch-flying-snakes/>

Watch some in of them in action:

<https://www.youtube.com/watch?v=16aGSx9gFO4>

Write a fiction story based on fact in which you imagine a situation involving one of these snakes! Perhaps it could be about a character who is told about flying snakes in the rainforest but believes them to be myths and goes in search of the truth.

Make your story into a book, perhaps a picture story book.

Ask someone to film you reading your story aloud and showing the pictures. Either the video or book (or both!) can be your project.



## Flying fish

There are about 40 – 50 different kinds of flying fish. Their pectoral fins are large and shaped like wings. A flying fish swims fast, moving its tail to help give it speed. It goes fast enough to be able to leap into the air, open and tilt its wing-like fins to get lift, and glide for about 50 metres. It folds its fins and re-enters the water. If it wants to keep gliding, it goes low enough for its tail to push against the water to give it another lift.

Read more about flying fish, and see pictures.

<https://www.nationalgeographic.com/animals/fish/group/flying-fish/>

[https://www.softschools.com/facts/animals/flying\\_fish\\_facts/318/](https://www.softschools.com/facts/animals/flying_fish_facts/318/)

[https://kids.kiddle.co/Flying\\_fish](https://kids.kiddle.co/Flying_fish)

Make a flying fish kite

In Japan, traditional carp kites are flown on Children's Day - see them here:

<https://www.kidcyber.com.au/celebrationsjapanese-children>

After finding out about flying fish, you can adapt the carp to look like a flying fish. Work out a way to add the wings to your fish shape, and draw the tail to look like that of a flying fish.

You need:

Thin fabric

Thin wire

Glue

Felt pens

String

Scissors

Draw a fish shape and copy it so you have two the same.  
Join them by gluing the edges together... but leave the mouth open.  
Decorate the fish as you like.  
Make a ring of wire the size of the fish's mouth.  
Fold and paste the mouth end of the fish over the wire.  
Attach string to each side of the mouth.  
Attach a long piece of string to that loop.  
Hang the fish where it will catch a breeze and 'fly'.

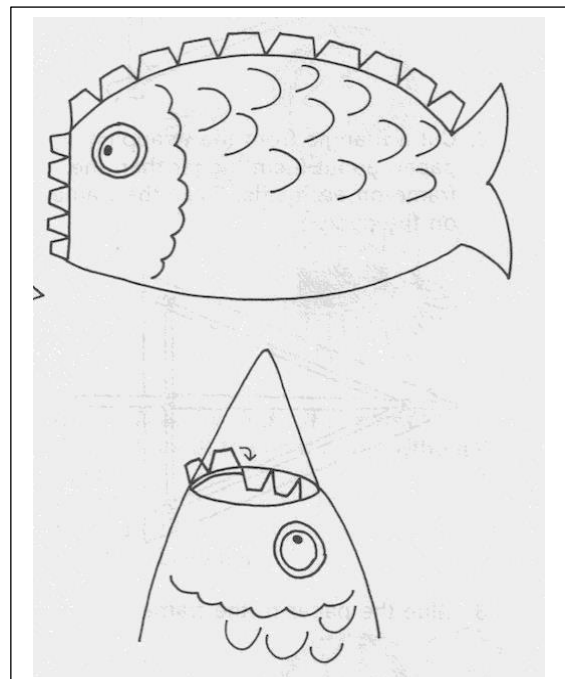



## Flying seeds

Have you ever blown onto a dandelion and watched the tiny parachutes fly off?



The seeds fly along and to land somewhere away from the parent plant. Hopefully a few seeds will land onto soil where they can grow.

This is **seed dispersal by wind**.

Seeds spread by the wind have different designs that catch the breeze. For example, maple seeds are encased in small wings, and they spin off like small helicopters. The seeds of the cottontree develop fluff that catches the wind and takes them away. After poppy flowers die what looks like a pepper shaker is left, and when the wind blows the shaker the seeds fly out and blow away.

Find out about other plants that use wind to fly their seeds away to other places:

<https://www.sciencelearn.org.nz/resources/103-seed-dispersal>

<https://www.kidcyber.com.au/seeds-and-bulbs>

<http://theseedsite.co.uk/sdwind.html>

There are a couple of small videos here as well as information:

<http://www.mbgnet.net/bioplants/seed.html>

Not all the seeds will land somewhere where they can grow. What could happen to many of the seeds?

Make a board game with landing spots that dictate what happens, such as miss a turn, bird eats seed or some other disaster. Use tokens or player pieces and dice. Invent your own layout: for example, a different start place for each player or use have the same one. Destination could be a garden.

Each player will have a set of tokens that represent a number of seeds, and the starting point is the moment the seeds fly off (maybe when a 6 is rolled). Along the way things may happen to delay some seeds, or some may land in the wrong spot and won't be able to grow.

The winner is the player who gets most of their seeds to the end, which is the spot where they can germinate and grow.

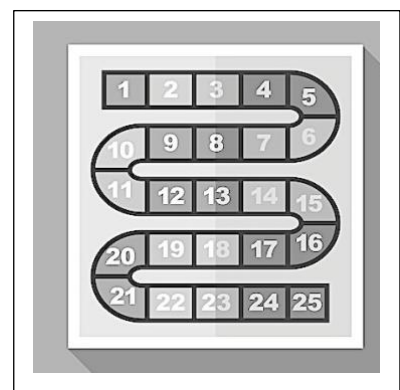

## Flying in Mythology

Myths are ancient traditional stories, usually about a hero or amazing event. There is usually no real fact or natural explanation, especially stories that involve a natural phenomenon that in ancient times defied explanation.

Two myths that involve flying are those of Icarus and Pegasus.

Read the stories and choose one of them to retell as a graphic story, or comic strip.

The story of Icarus:

<https://www.dltk-kids.com/world/greece/m-story-icarus.htm>

The story of Pegasus:

Thousands of years ago there was a kind and just king who had two sons. The eldest was Bellerophon, who was the heir to the throne. He didn't wish to be king. He was fascinated by nature, and especially the sky. He observed the sky both day and night, and read all he could find about it. One of the stories he read was of Pegasus, a winged horse. He longed to find this horse and fly into the sky.

One sad day, the king died and it was time for Bellerophon to be crowned in his place. However, Bellerophon ran away and hid in the forest. He wandered through the forest for seven years, learning about the animals and spending hours gazing at his beloved sky. He hoped always to find Pegasus, the winged horse.

One night Bellerophon had a dream in which his father appeared and told him that he would find what he was searching for. When Bellerophon woke he saw before him the beautiful Pegasus, his white coat glistening in the moonlight glistened and his silver wings gleaming. Bellerophon walked slowly toward the magical horse, who pranced away and disappeared into the forest.

Each night the horse came sailing in on shimmering wings, but each time Bellerophon approached him he pranced away. Then one night Bellerophon began to tell the legend of the winged horse. As he spoke the words of the ancient story, the horse pricked up his ears and stepped towards Bellerophon. When he'd finished the story, Pegasus bent down and allowed the astonished Bellerophon to climb onto his back. Together they soared into the sky, never to be seen again.

Nobody is sure about what happened to Bellerophon and Pegasus. Some said that because they flew so high they became stars in the night sky.

What do you think?



## Comparison

Lawrence Hargrave's experiments and discoveries did not lead to him developing a flying machine, but helped others achieve that dream.

Read about Hargrave: <https://www.kidcyber.com.au/lawrence-hargrave>

Read about the Wright Brothers: [www.kidcyber.com.au/wright-brothers](http://www.kidcyber.com.au/wright-brothers)

Compare the Wright Brothers and Lawrence Hargrave, using a Venn diagram, which is two intersecting circles. In one circle you make notes about Hargrave and in the other notes about the Wrights. In the overlapping part you make notes that are common to both. The notes need to be just a few words or you will run out of space.

Draw your diagram like this on a large piece of paper:

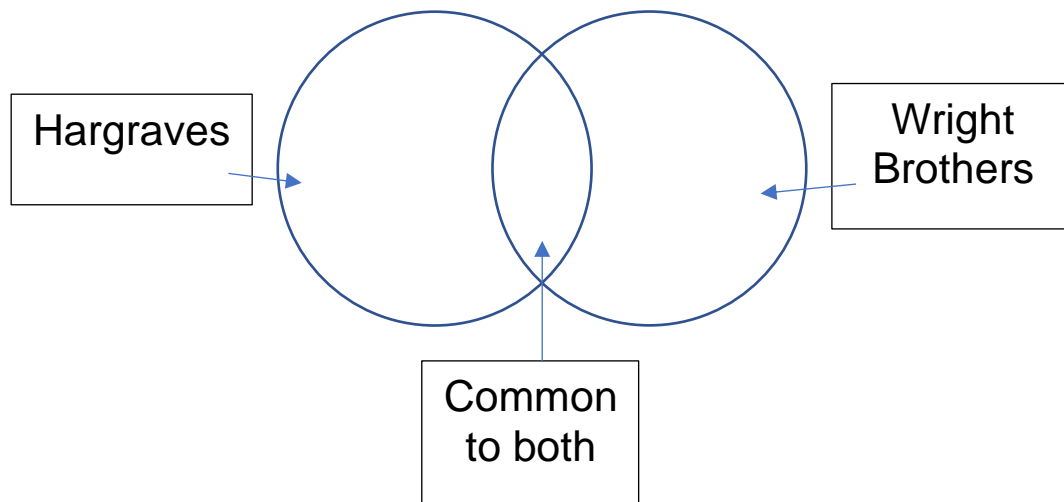

A box kite is a tailless kite that is a long box open at each end and sometimes in the middle as well. You might like to make a box kite similar to Hargrave's. Check the instructions below for an easy one, or you could search the internet or books for another design.

[https://www.ehow.com/how\\_4882168\\_make-box-kites.html](https://www.ehow.com/how_4882168_make-box-kites.html)

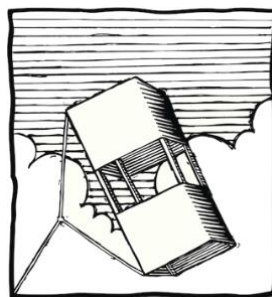

**Kites fly!**  
Make some kites.

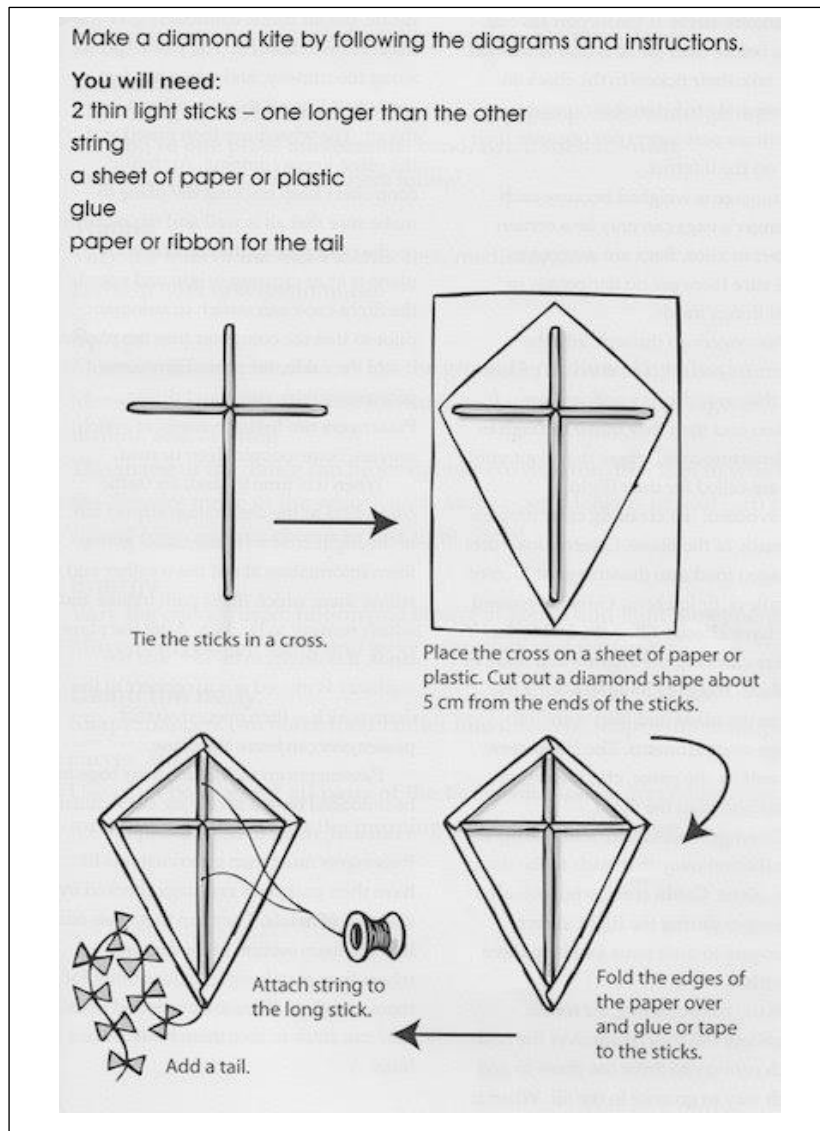

**Three other shapes :**

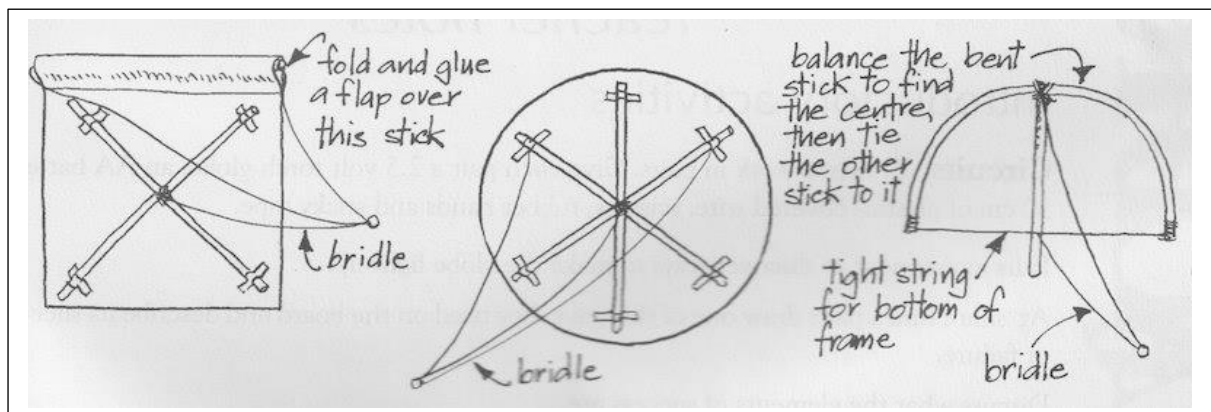

**Make an A-Z list of things that fly**

<b>A</b>	<b>B</b>
<b>C</b>	<b>D</b>
<b>E</b>	<b>F</b>
<b>G</b>	<b>H</b>
<b>I</b>	<b>J</b>
<b>K</b>	<b>L</b>
<b>M</b>	<b>N</b>
<b>O</b>	<b>P</b>
<b>Q</b>	<b>R</b>
<b>S</b>	<b>T</b>
<b>U</b>	<b>V</b>
<b>W</b>	<b>X</b>
<b>Y</b>	<b>Z</b>

## Research Notes

Print off and use, or you can make your own if you want more space.

My information about \_\_\_\_\_

What I already know

### Questions and notes

Q1.

Q 2.

Q 3.

Q 4.

## Experiment Recording Sheet

### Paper planes and gyrocopters

Name of plane                      How far do you think it will fly                      Actual distance flown

Name of plane	How far do you think it will fly	Actual distance flown

Best design \_\_\_\_\_ Why? \_\_\_\_\_

### Rotocopters

Height of drop (same for original and variations ) \_\_\_\_\_

Time for original to reach the ground \_\_\_\_\_

My variations:

Highlight or \* the best one. How long did it take to reach the ground? \_\_\_\_\_  
Why do you think it worked best?



## Suggestions for good layout of charts

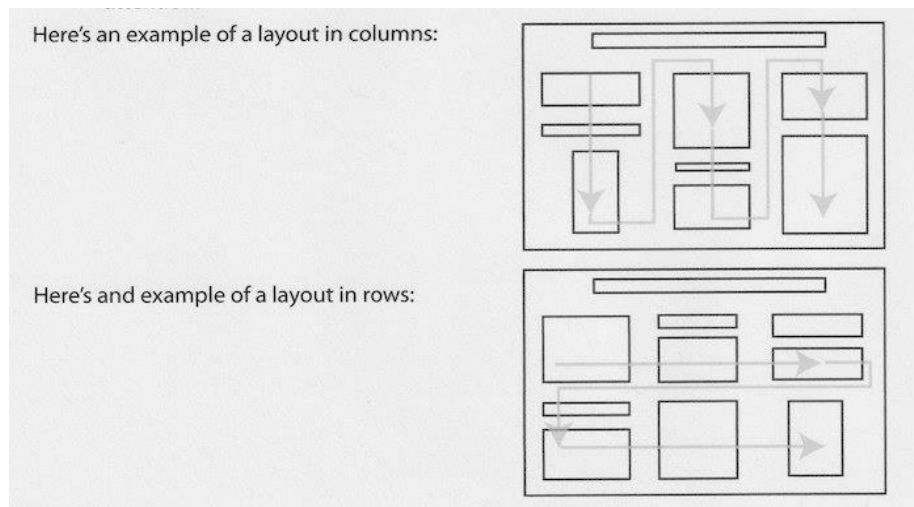

## Other ideas to do:

Make a diorama: a scene inside a box. This example is about a book, but you can choose any aspect of flight.

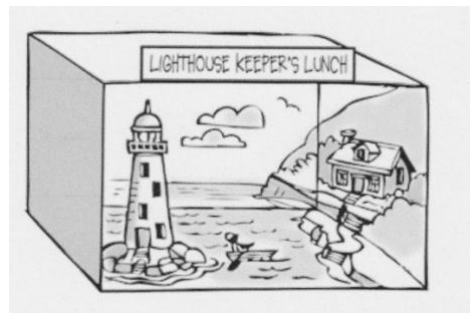

Make a mobile of things that fly  
The example shows some different ways of hanging things

